

| Załącznik do Katalogu Systemów Ogrodzeniowych

NOWE WZORY SEGMENTÓW  
**OGRODZEŃ POSESYJNYCH**

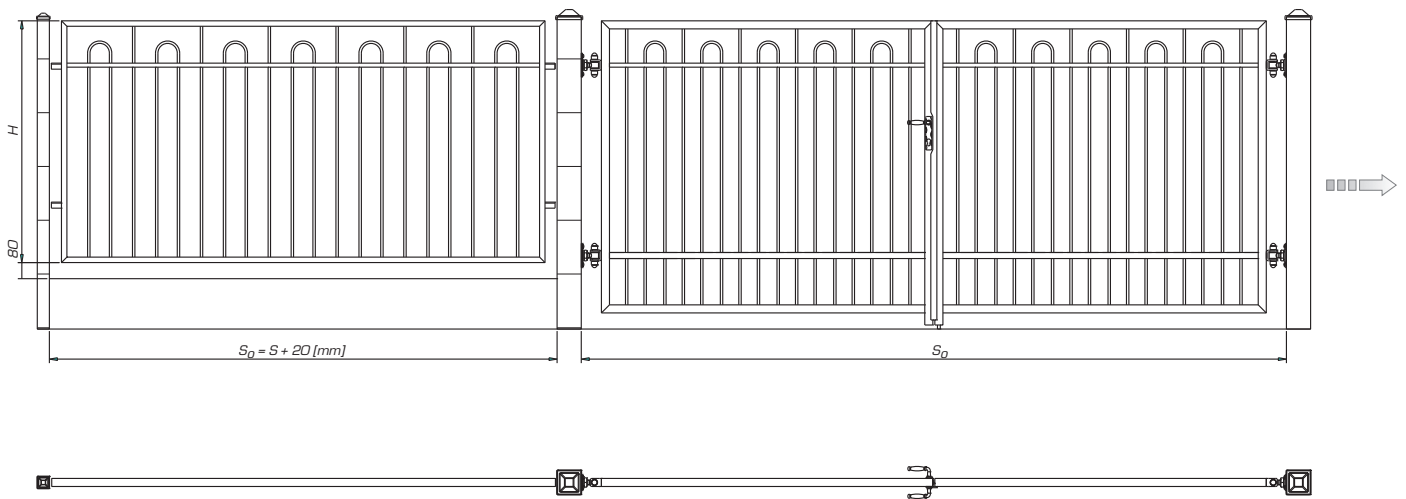

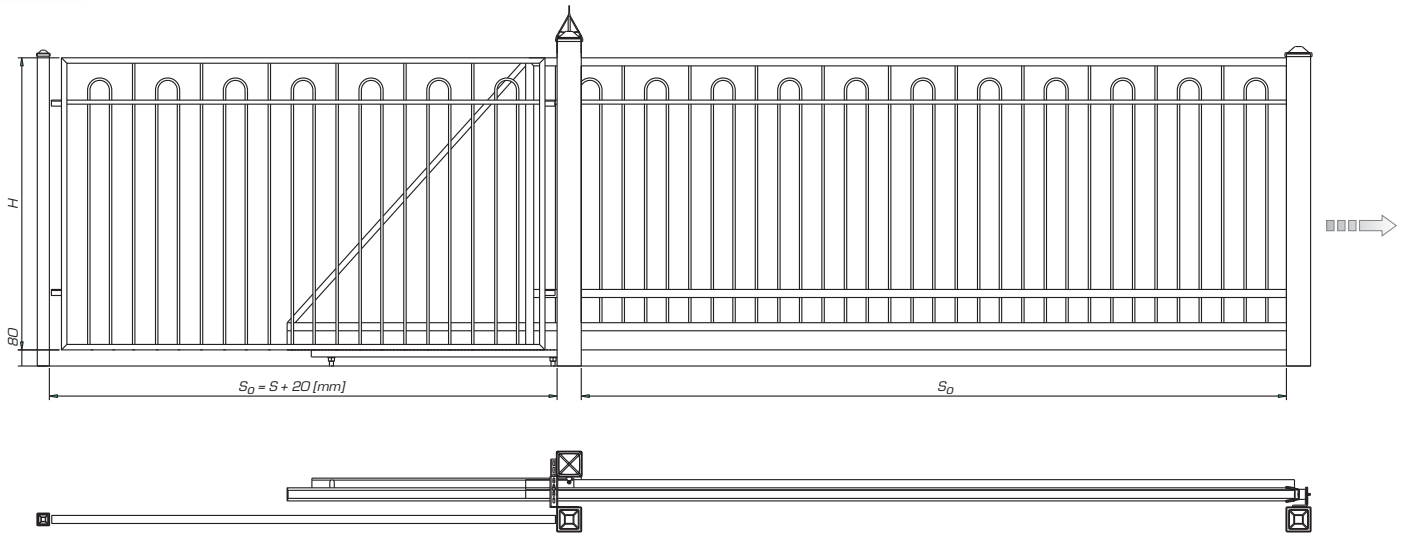

AW.10.73/P

(S) 2500 [mm] x (H) 900 [mm]

(S) 2500 [mm] x (H) 1450 [mm]

(S) 2500 [mm] x (H) 1200 [mm]

max: (S) 3000 [mm] x (H) 1600 [mm]

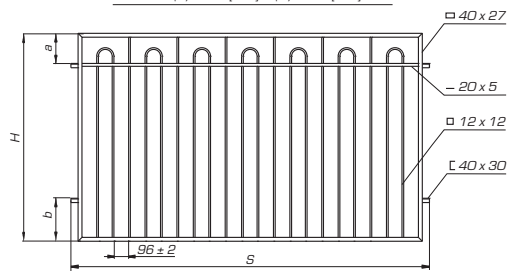

H=1450, a=210, b=300

H=1200, a=210, b=300

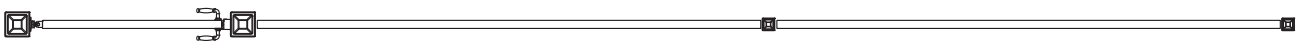
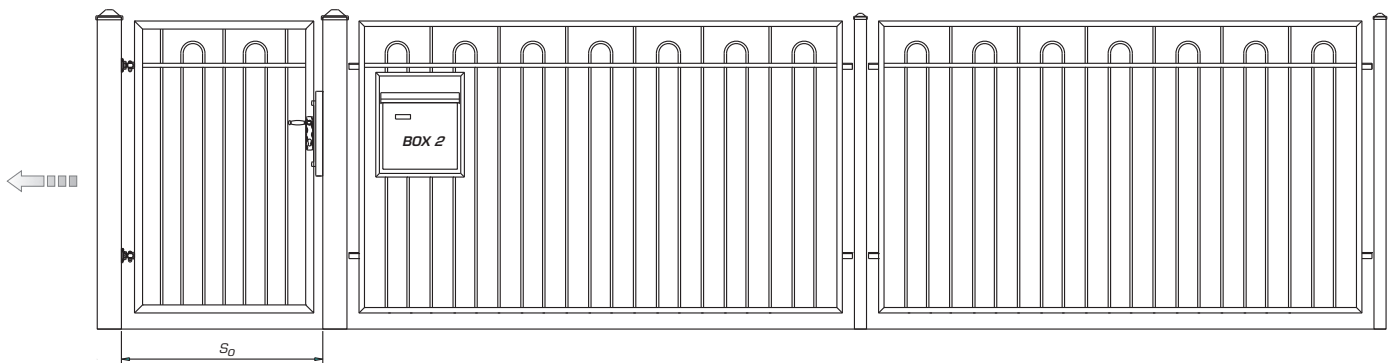
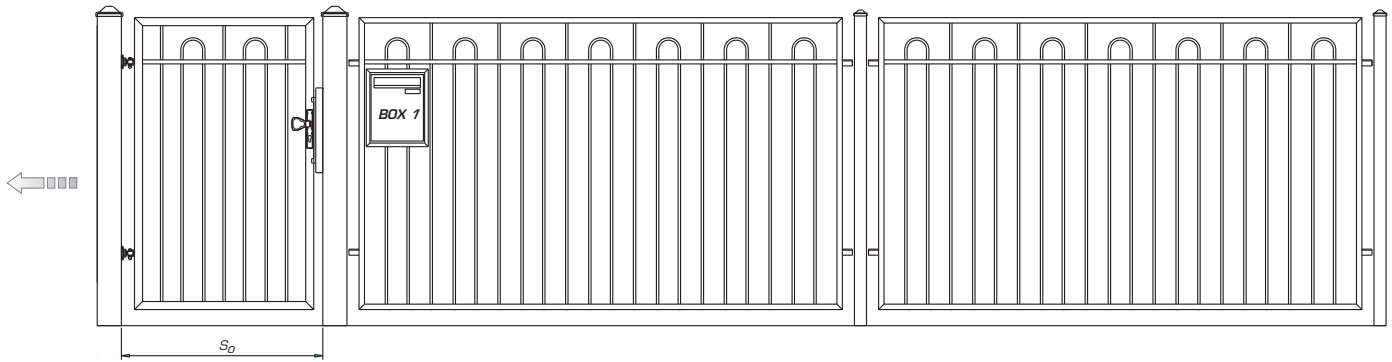

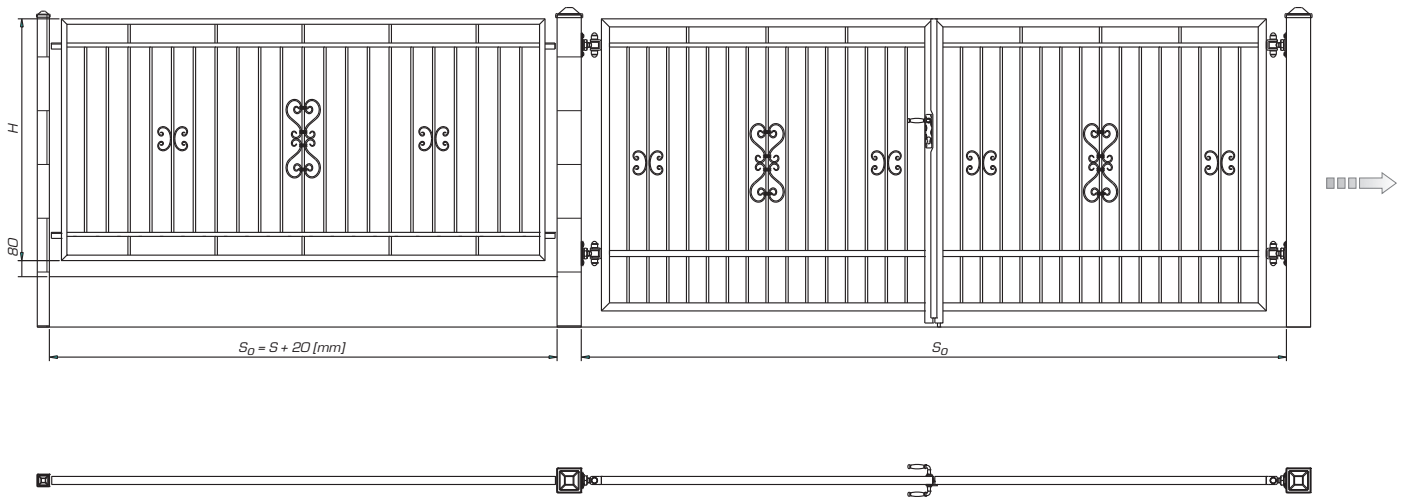
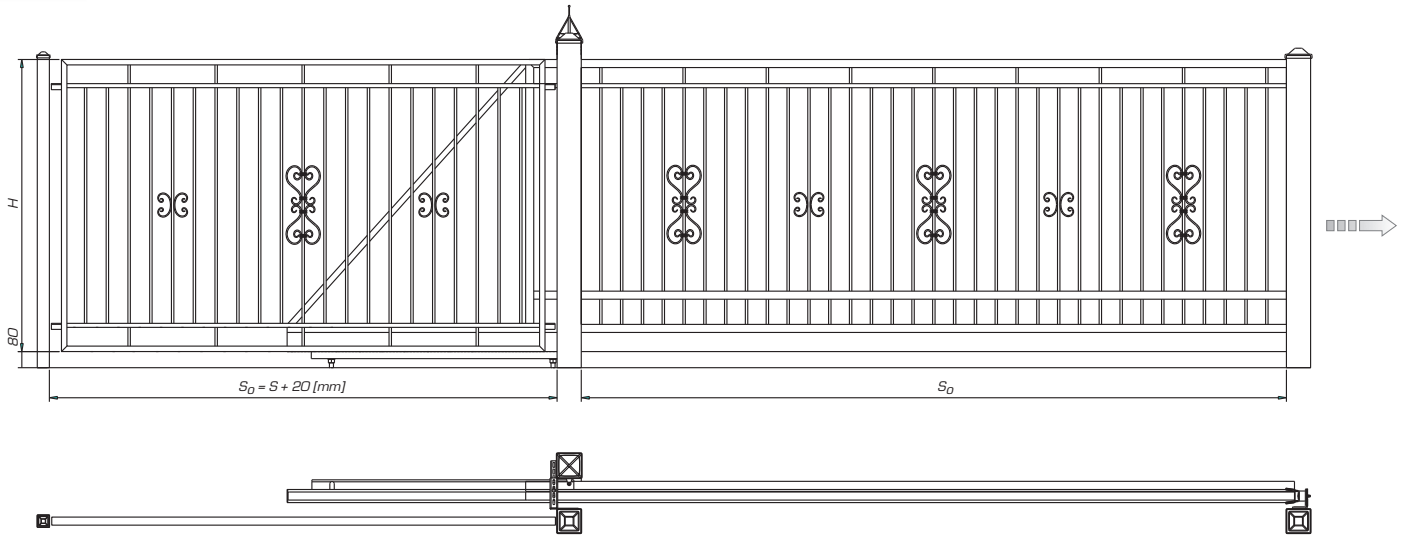

AW.10.74/P

(S) 2500 [mm] x (H) 900 [mm]

(S) 2500 [mm] x (H) 1450 [mm]

(S) 2500 [mm] x (H) 1200 [mm]

max: (S) 3000 [mm] x (H) 1600 [mm]

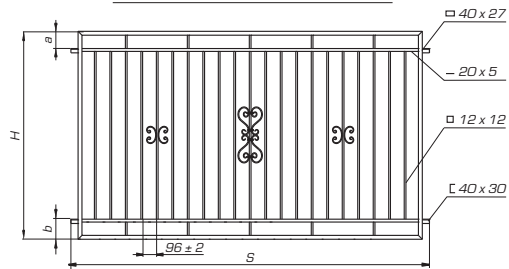

$H=1450, a=120, b=140$

$H=1200, a=120, b=140$

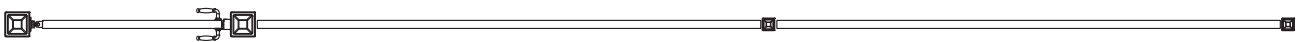
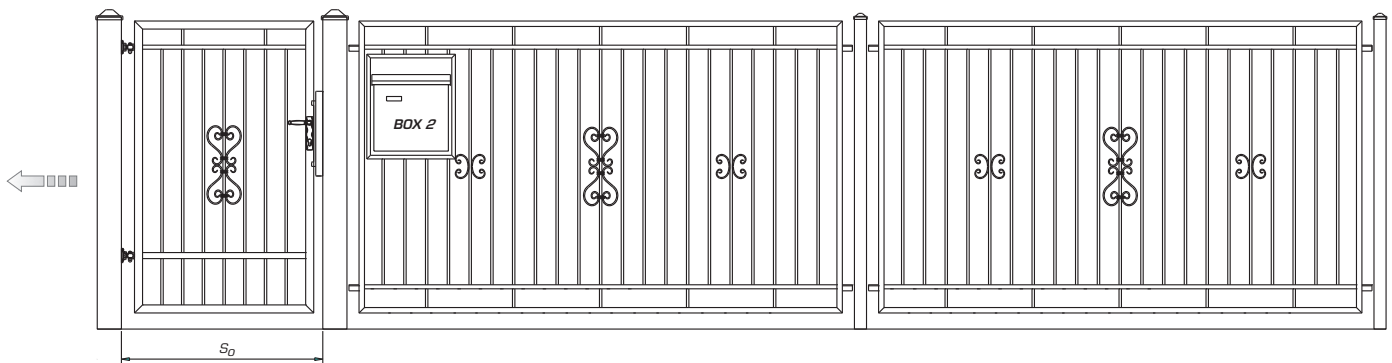
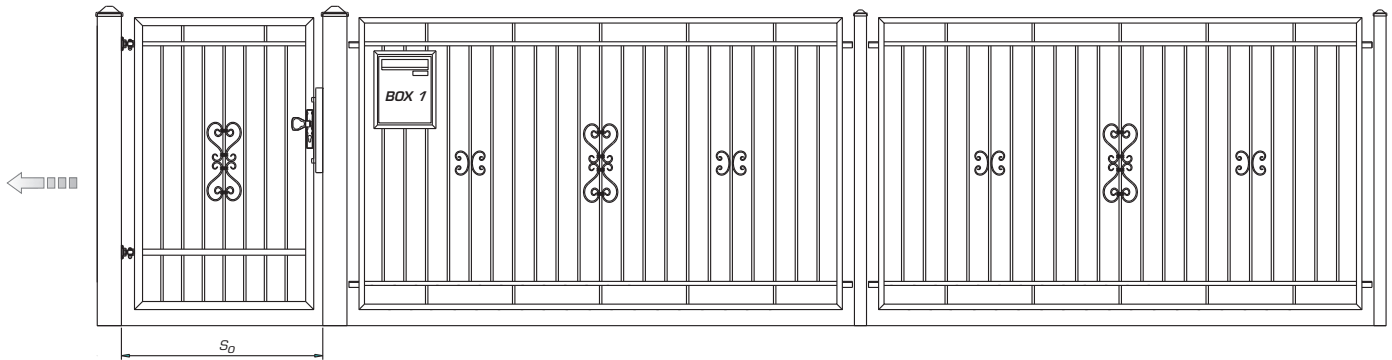

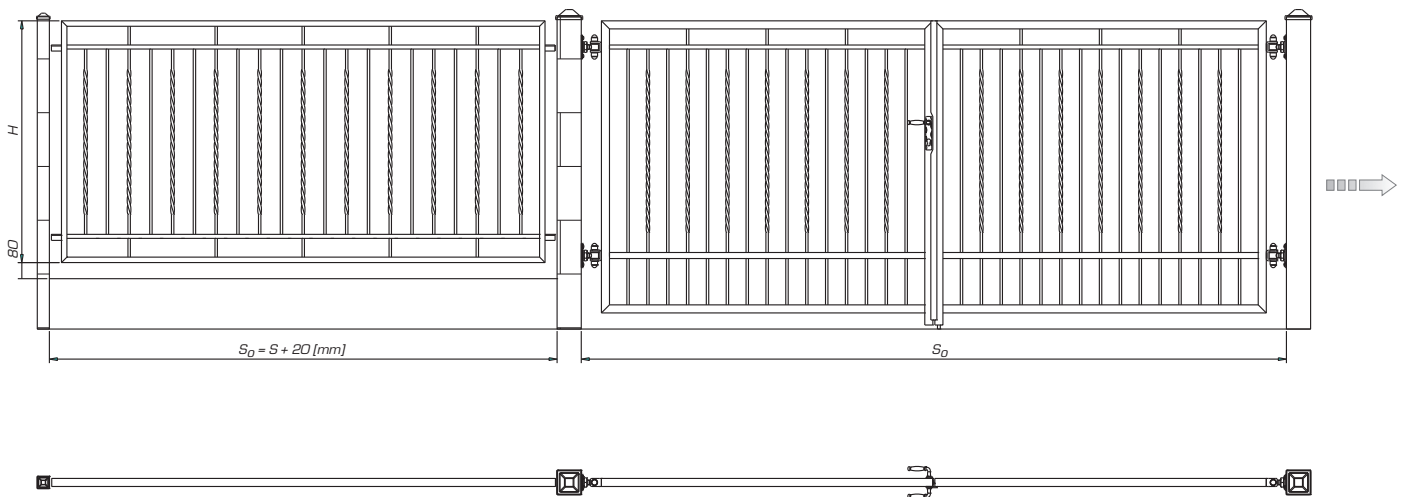
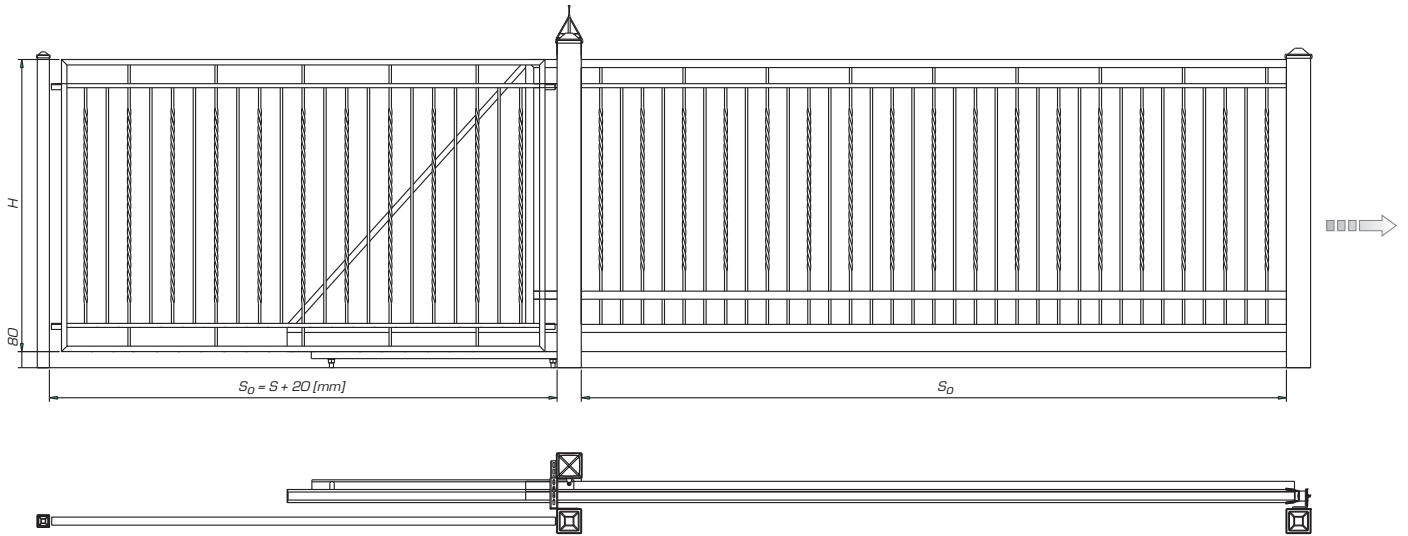

AW.10.75/P

(S) 2500 [mm] x (H) 900 [mm]

(S) 2500 [mm] x (H) 1450 [mm]

(S) 2500 [mm] x (H) 1200 [mm]

max: (S) 3000 [mm] x (H) 1600 [mm]

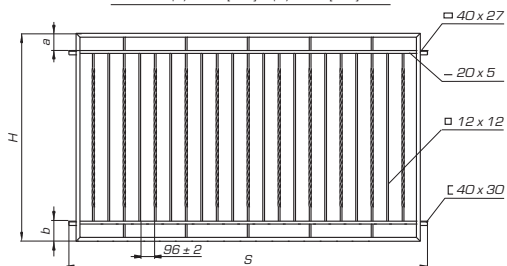

$H=1450, a=120, b=140$

$H=1200, a=120, b=140$

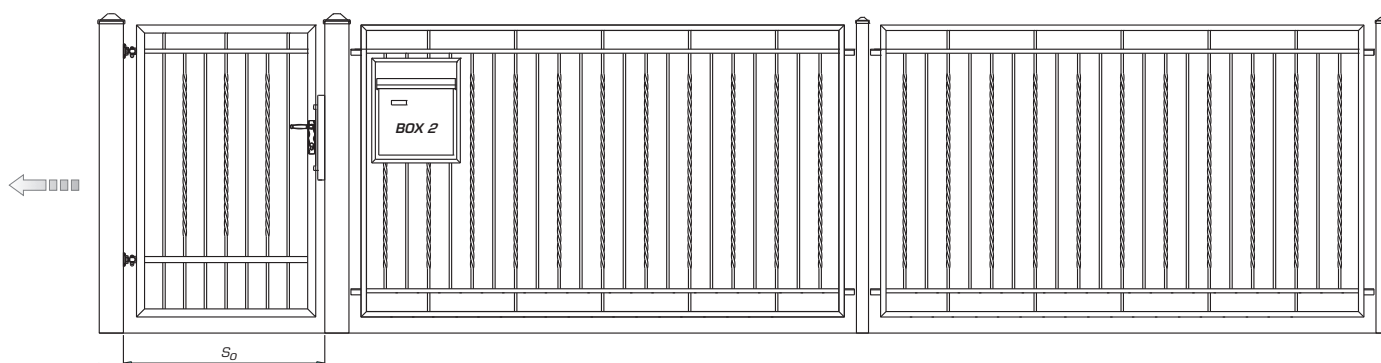
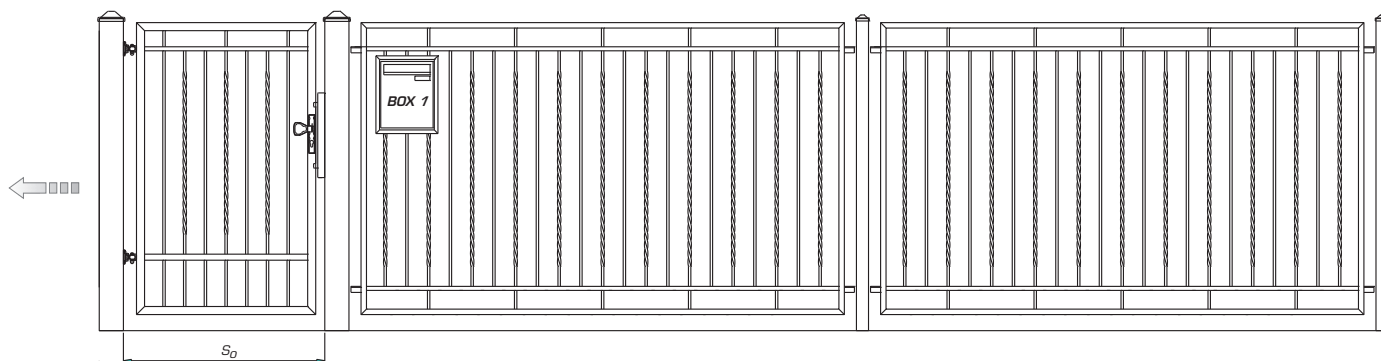

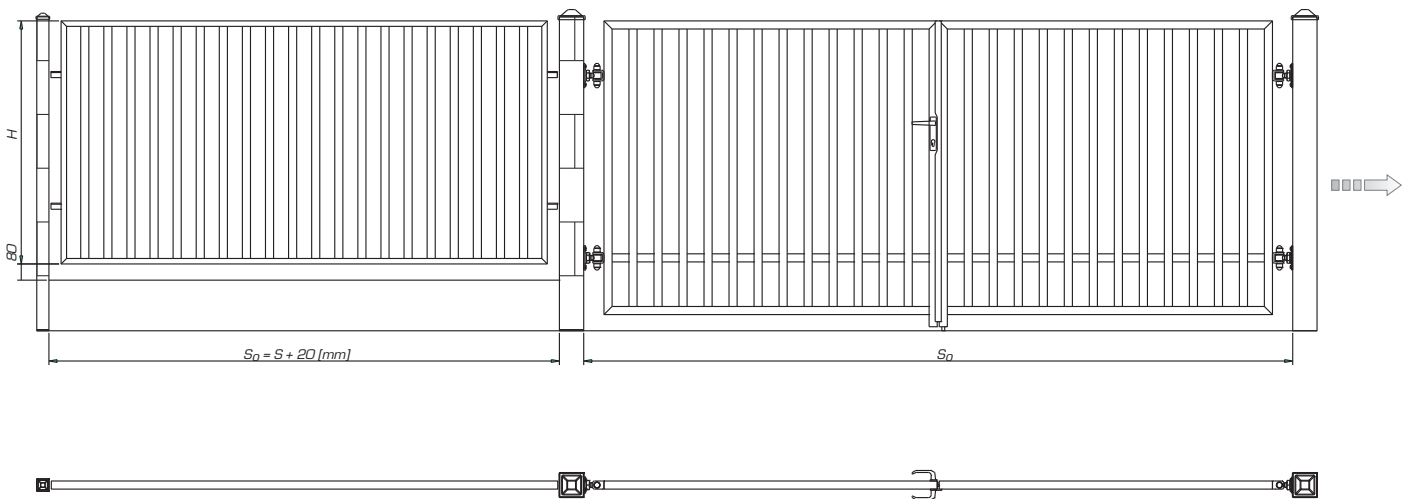
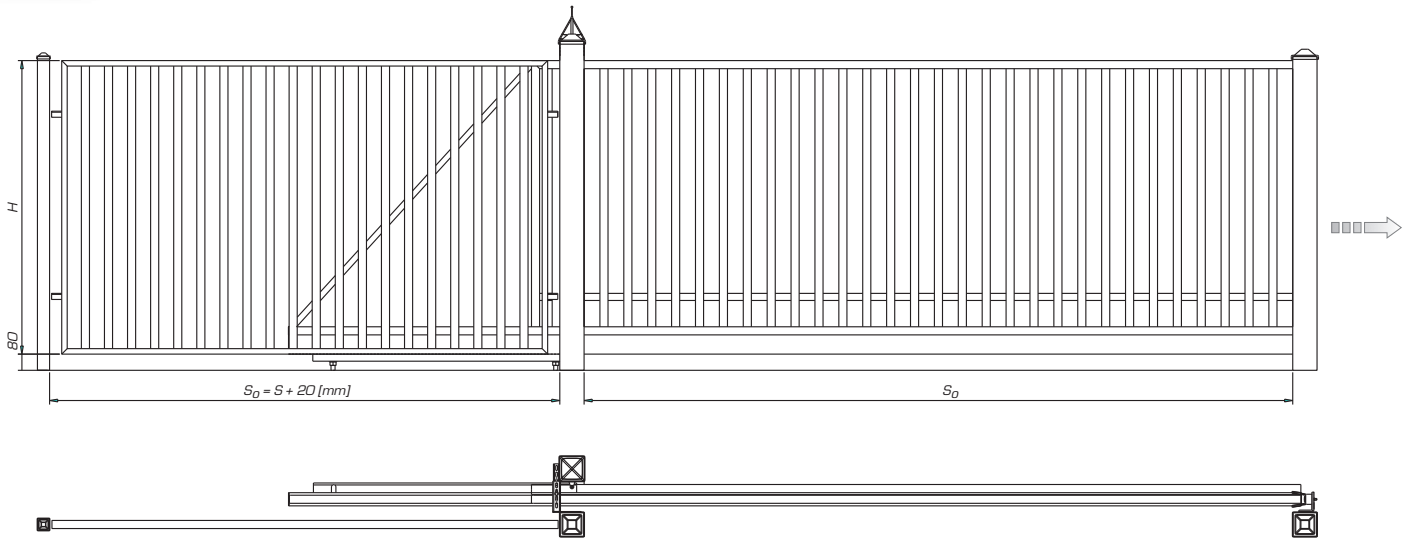

AW.10.70/P

(S) 2500 [mm] x (H) 900 [mm]

(S) 2500 [mm] x (H) 1450 [mm]

(S) 2500 [mm] x (H) 1200 [mm]

max: (S) 3000 [mm] x (H) 1600 [mm]

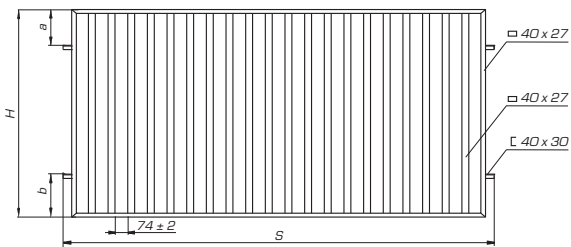

$H=1450, a=250, b=300$

$H=1200, a=250, b=300$



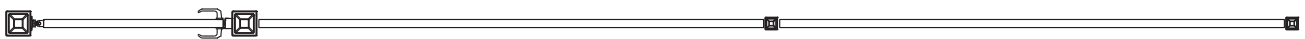
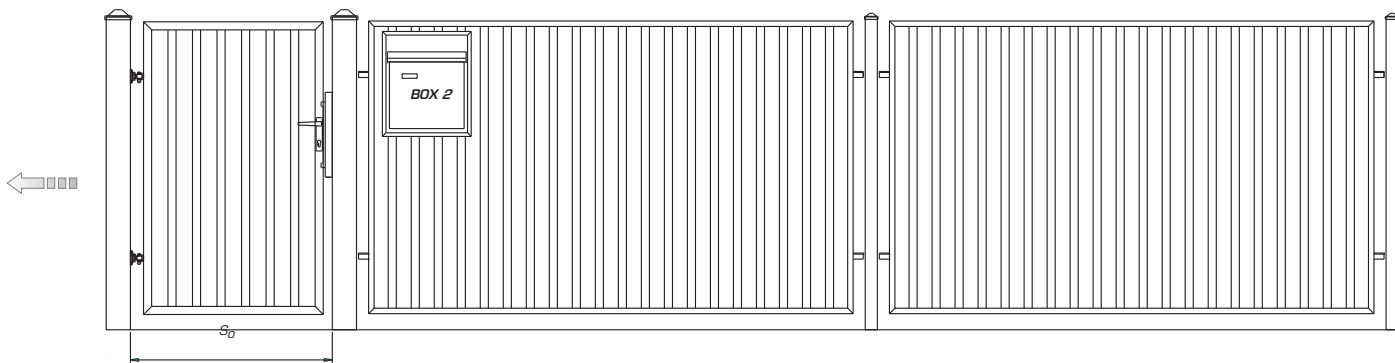
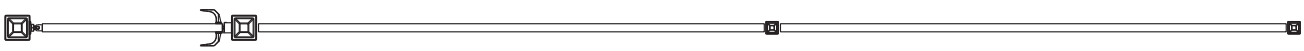
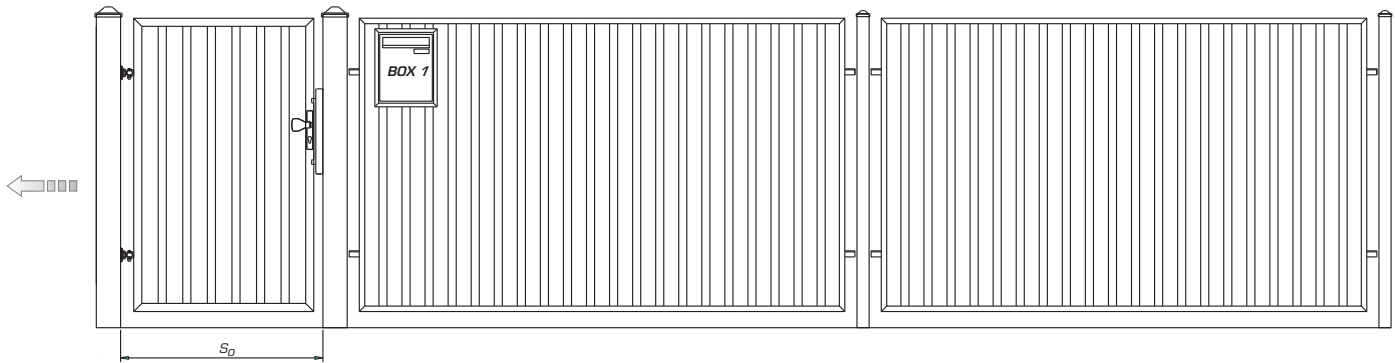

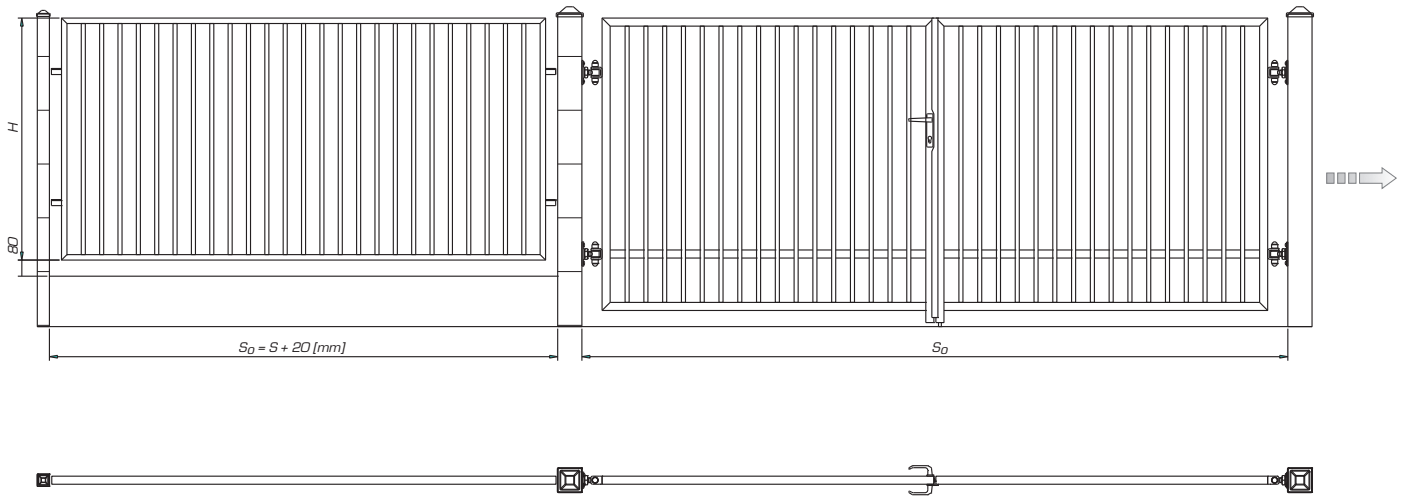
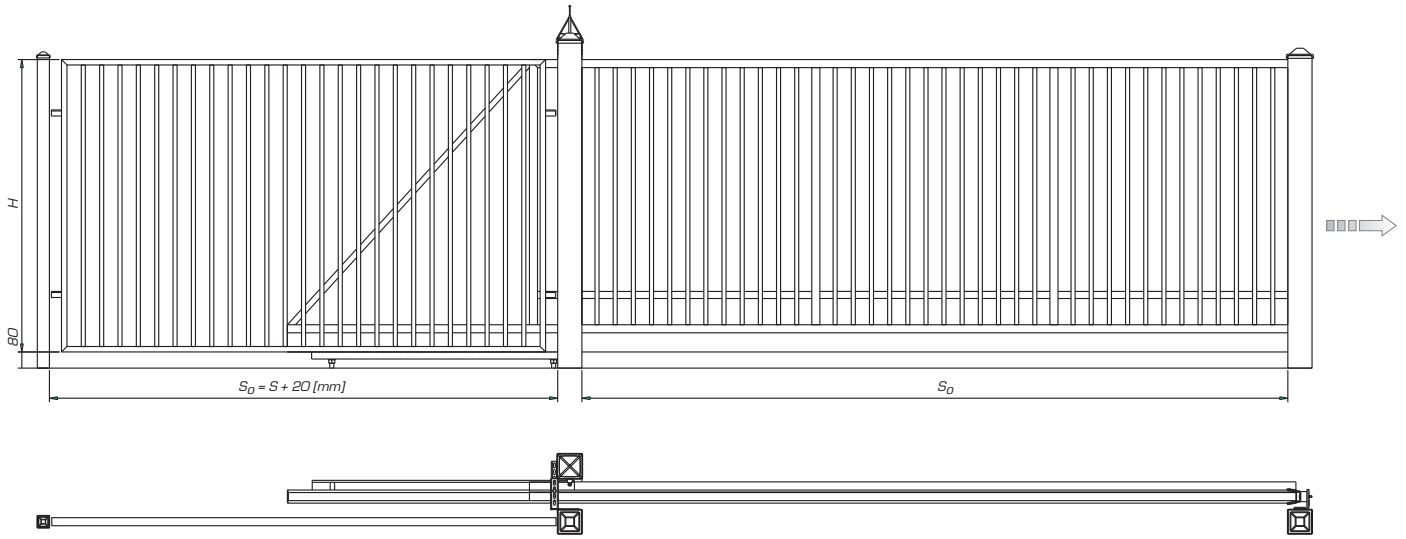

AW.10.71/P

(S) 2500 [mm] x (H) 900 [mm]

(S) 2500 [mm] x (H) 1450 [mm]

(S) 2500 [mm] x (H) 1200 [mm]

max: (S) 3000 [mm] x (H) 1450 [mm]

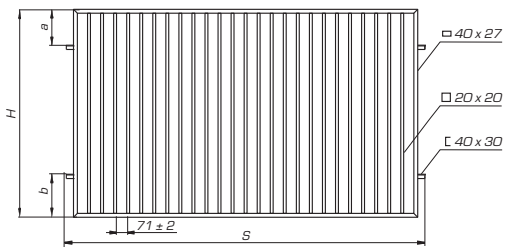

$H=1450, a=250, b=300$

$H=1200, a=250, b=300$

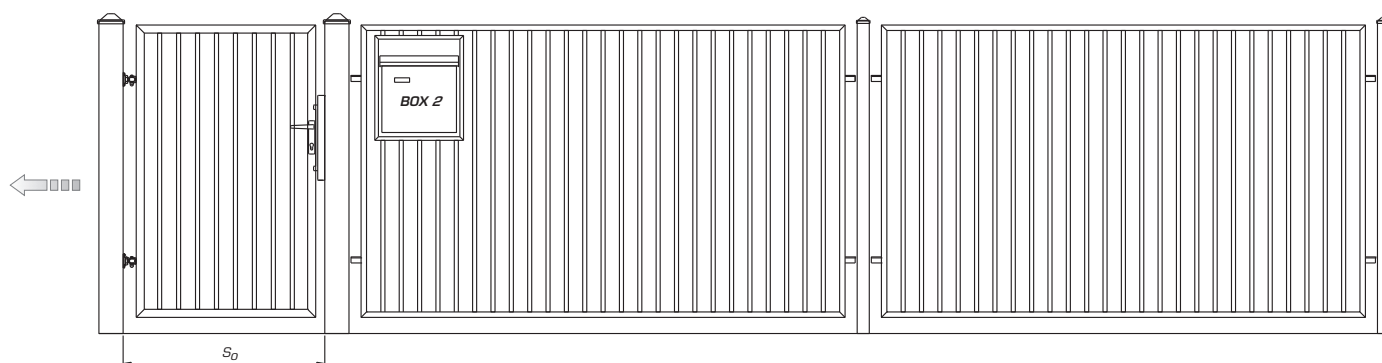
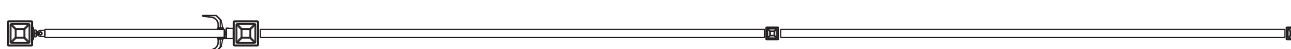
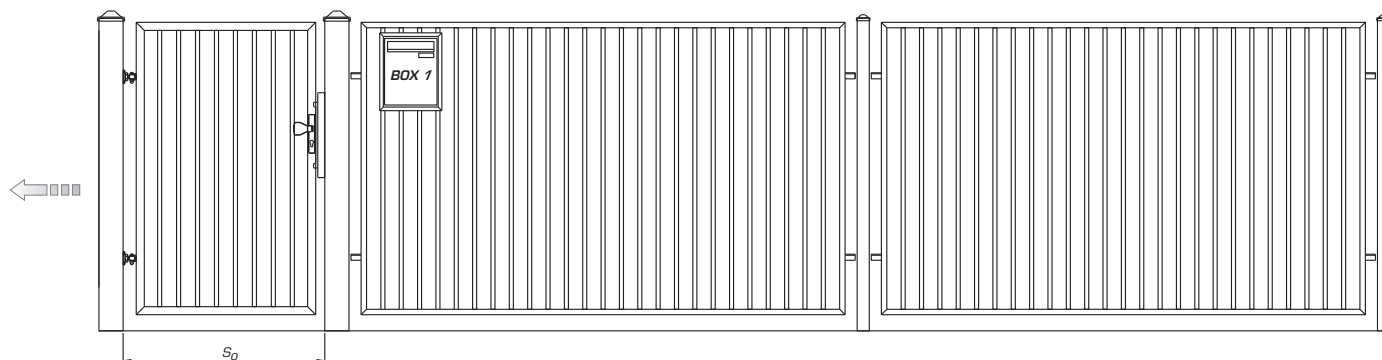

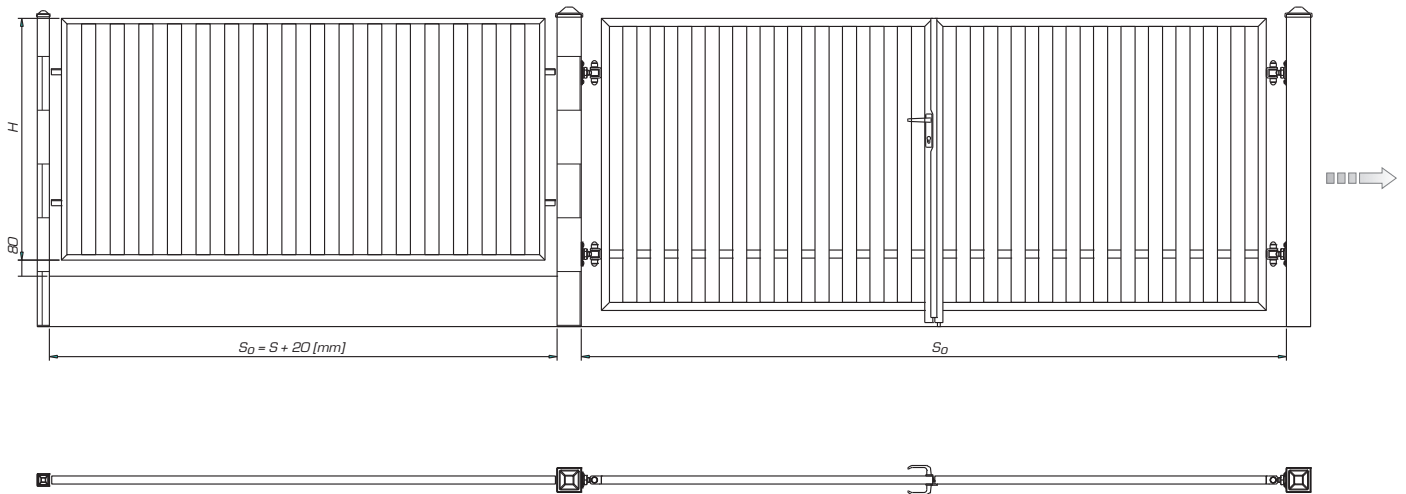
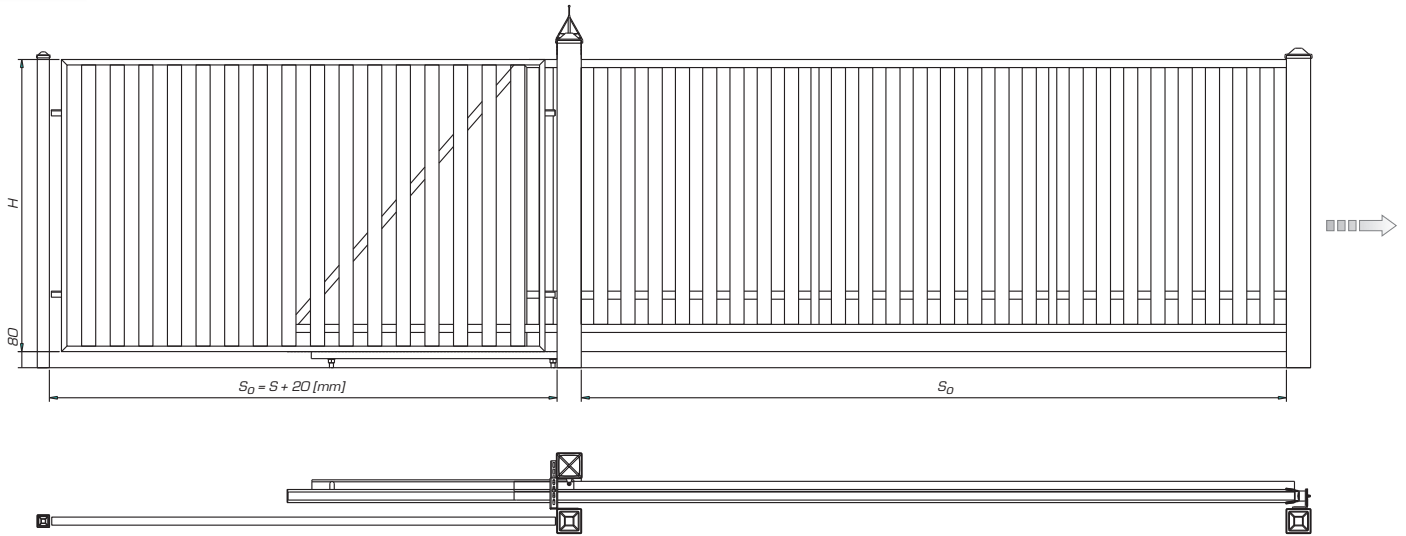

AW.10.72/P

(S) 2500 [mm] x (H) 900 [mm]  
(S) 2500 [mm] x (H) 1200 [mm]

(S) 2500 [mm] x (H) 1450 [mm]

max: (S) 3000 [mm] x (H) 1600 [mm]

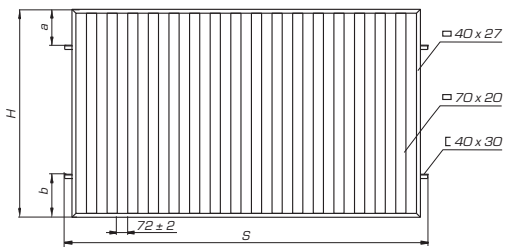

H=1450, a=250, b=300

H=1200, a=250, b=300

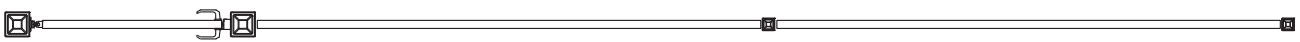
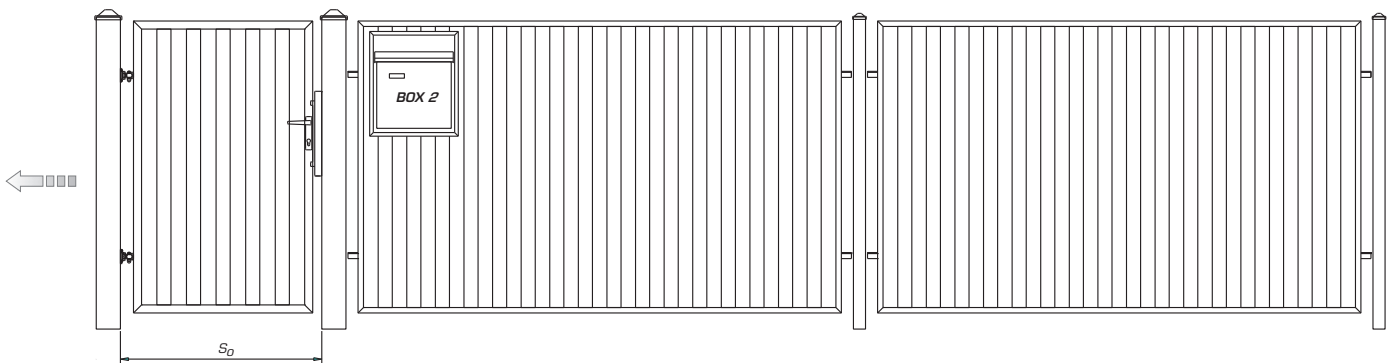
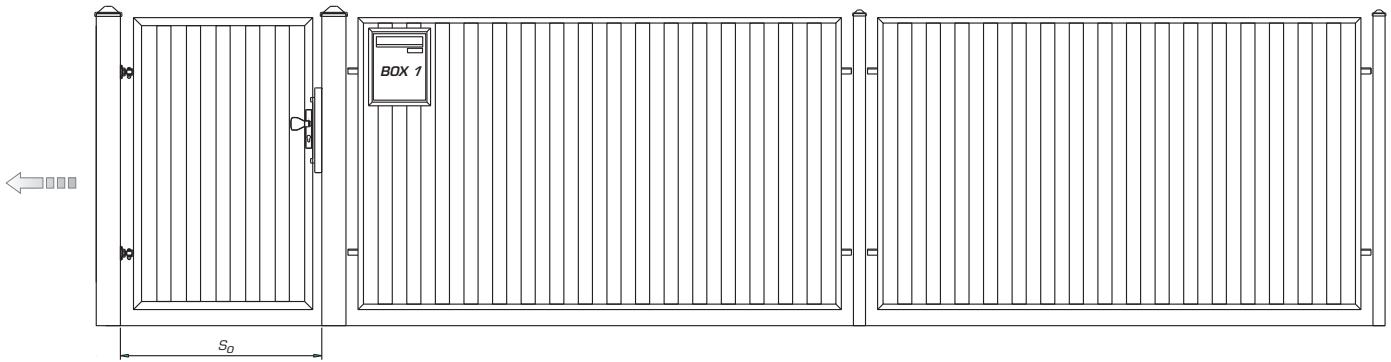

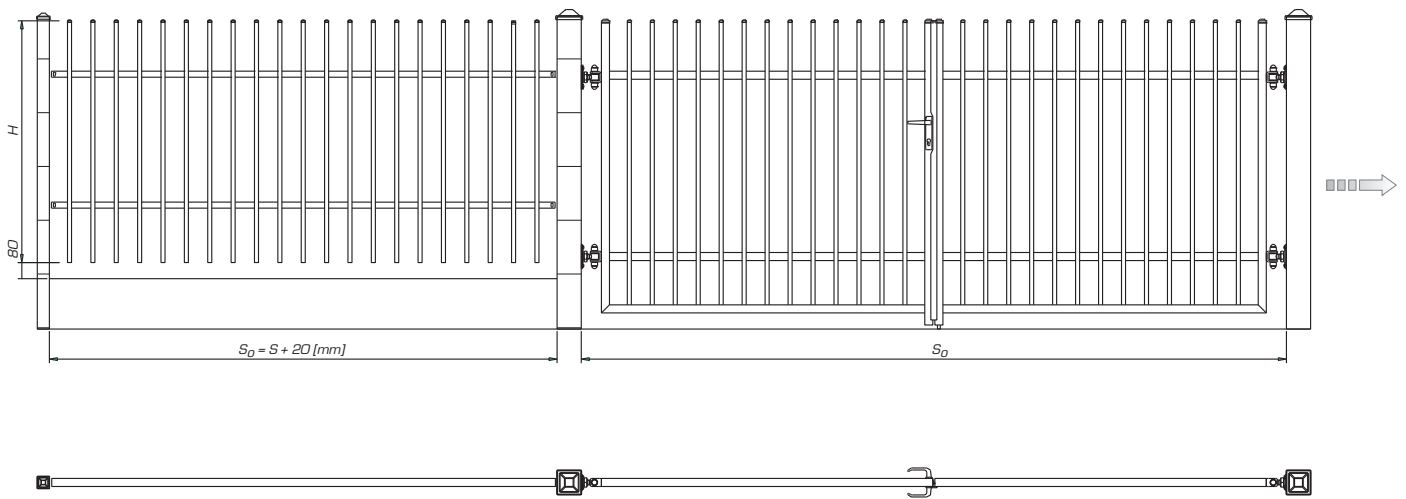
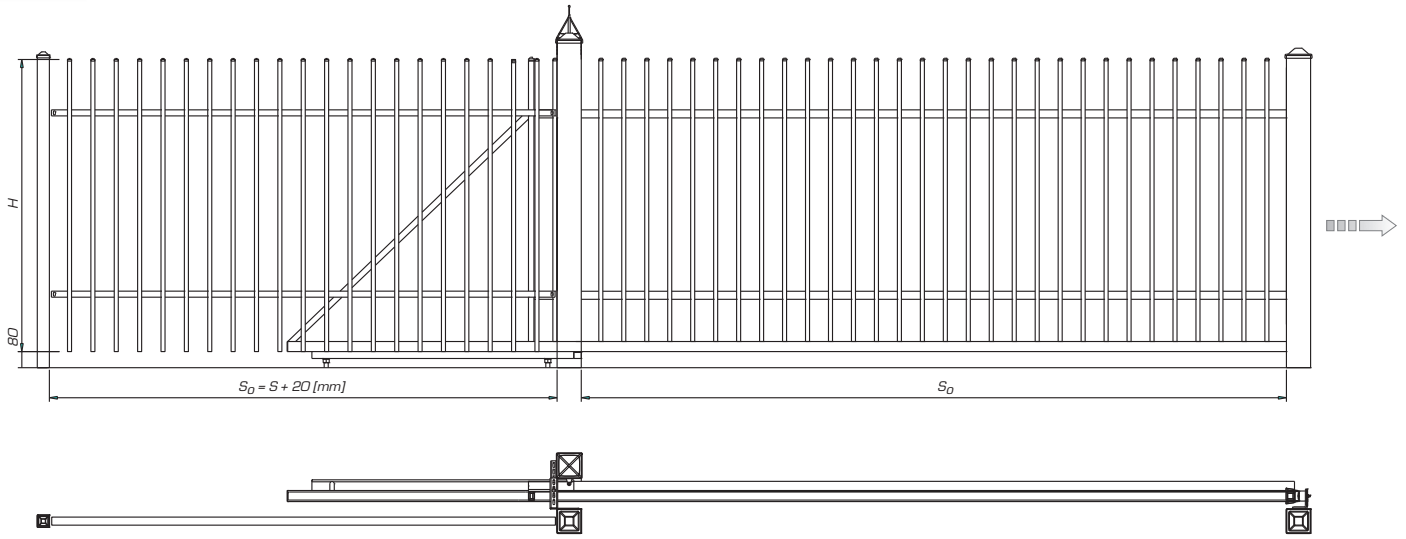

AW.10.80/P

(S) 2500 [mm] x (H) 900 [mm]  
(S) 2500 [mm] x (H) 1200 [mm]

(S) 2500 [mm] x (H) 1450 [mm]

max: (S) 2700 [mm] x (H) 1450 [mm]

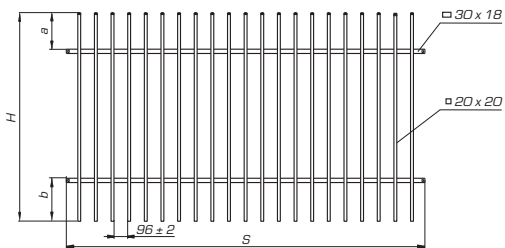

H=1450, a=250, b=300

H=1200, a=250, b=300

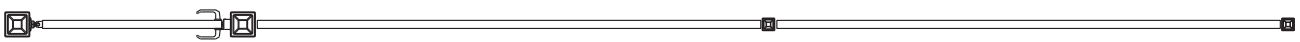
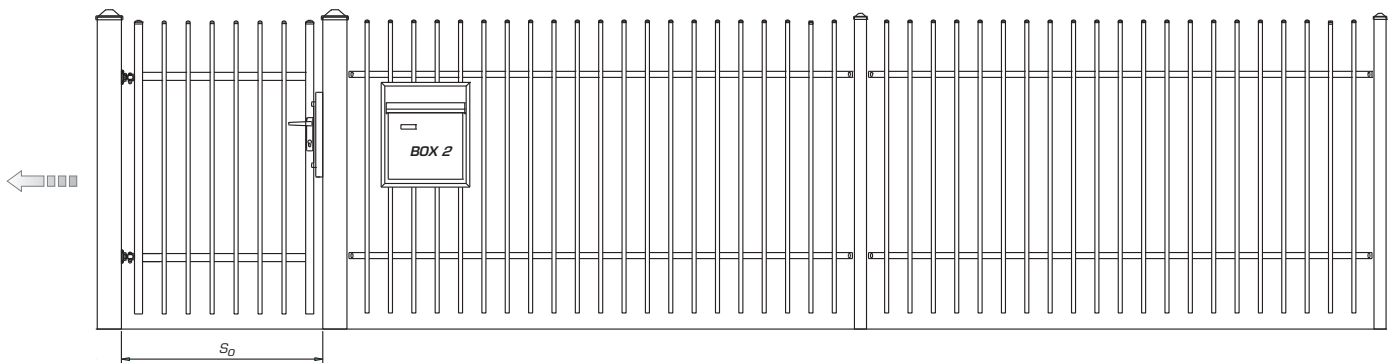
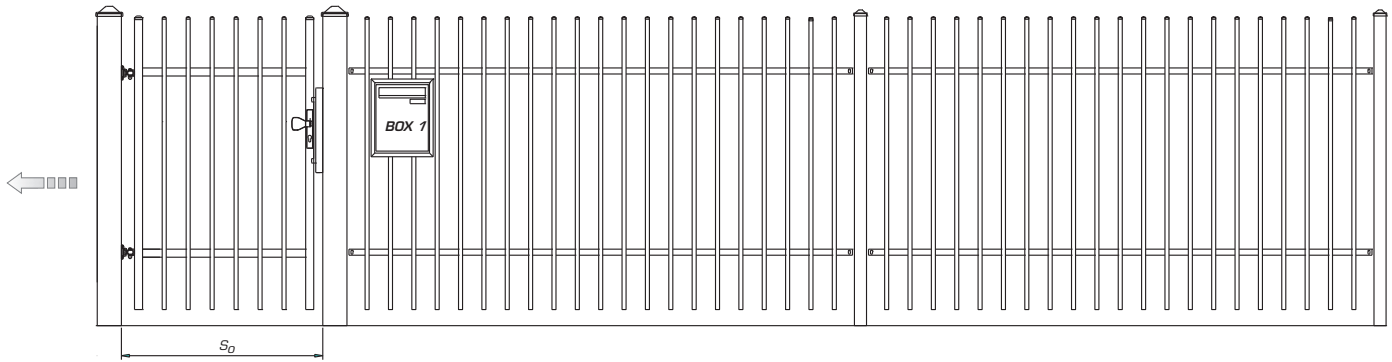

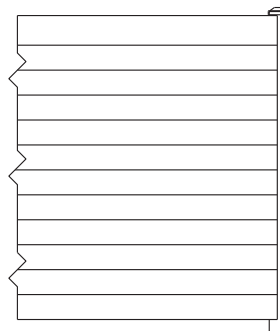
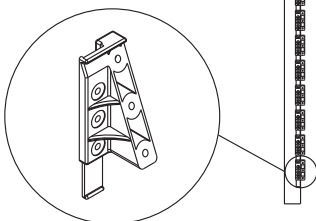
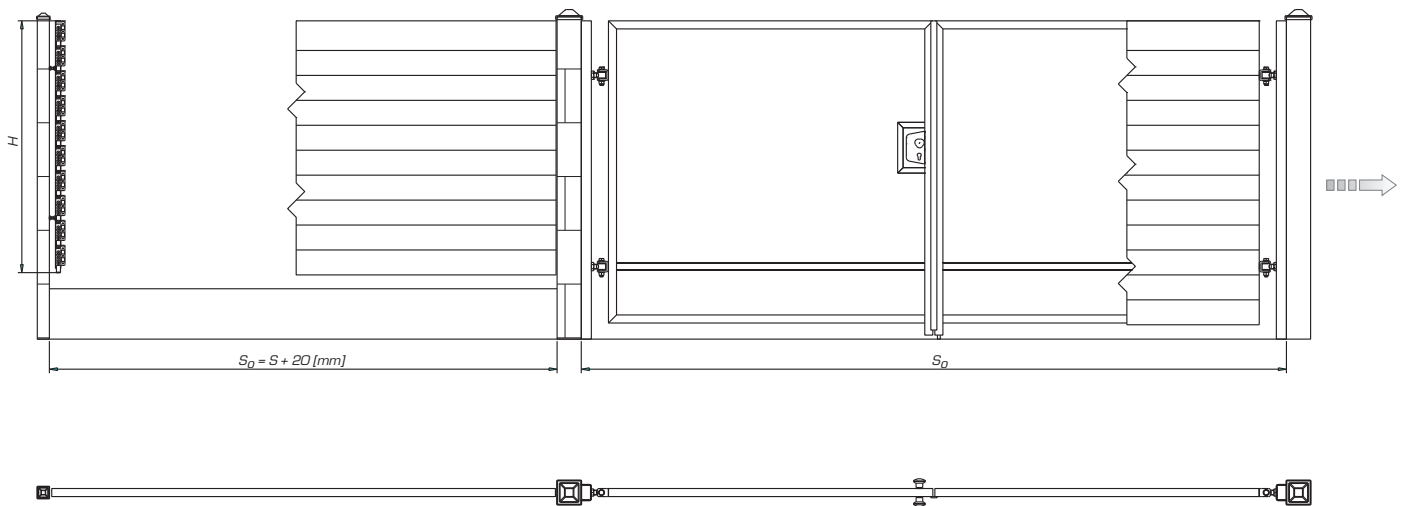
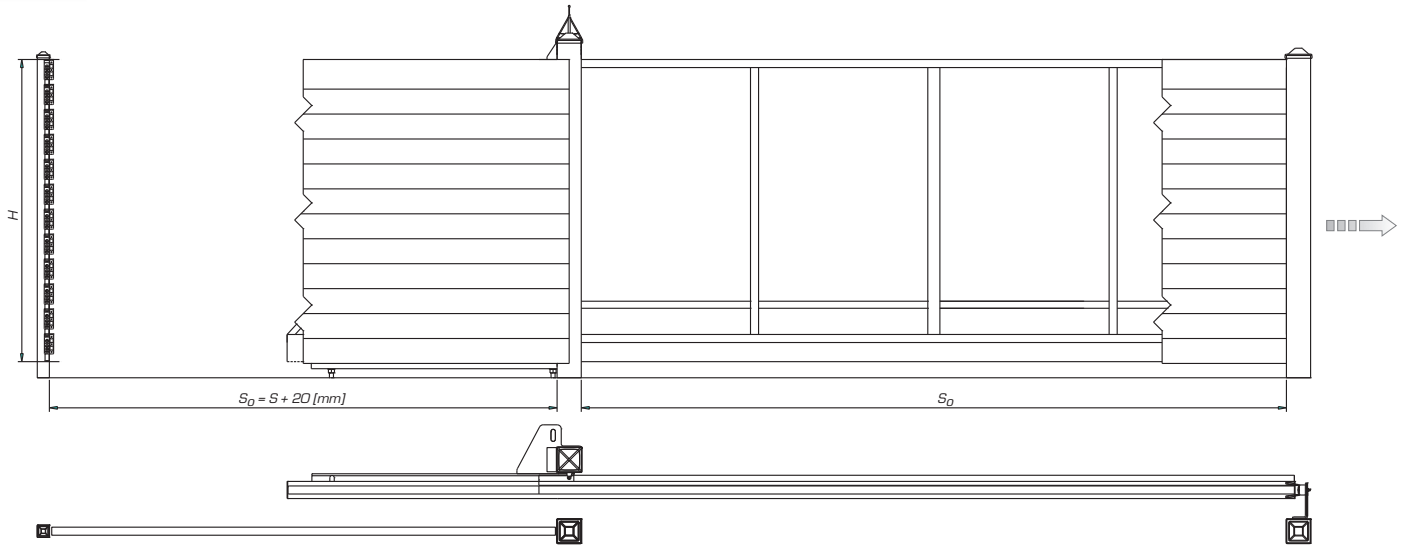



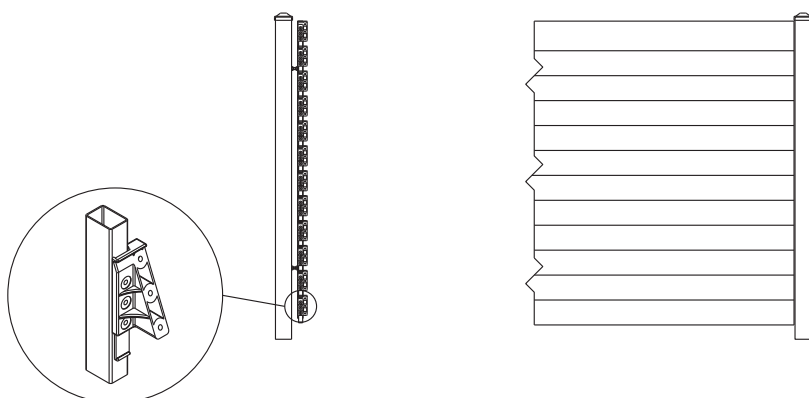
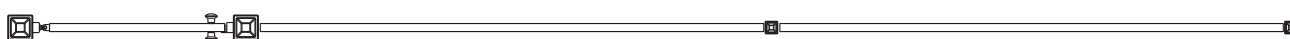
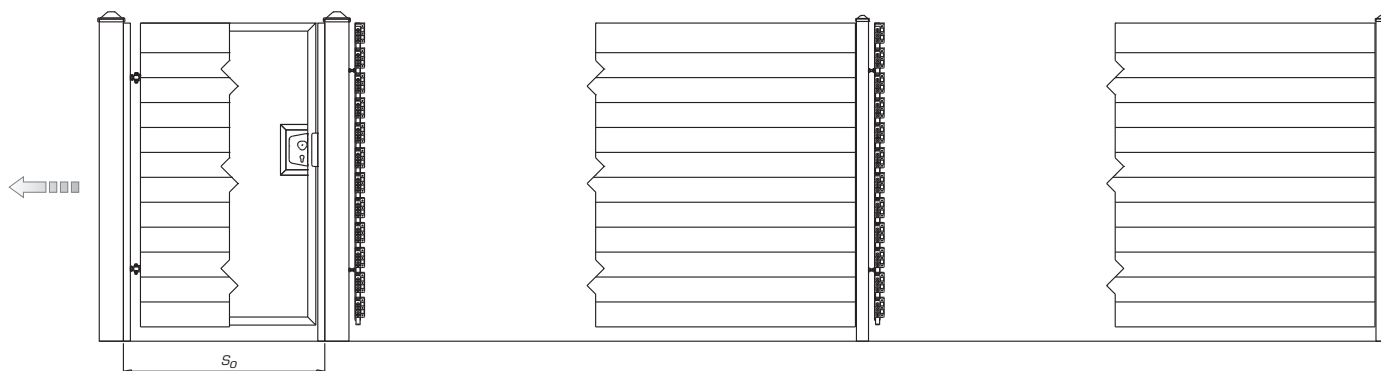
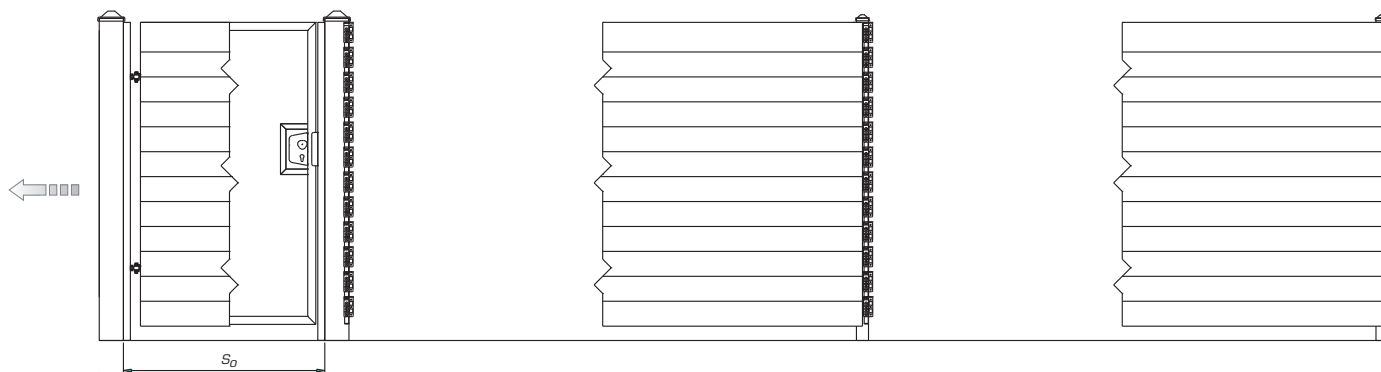

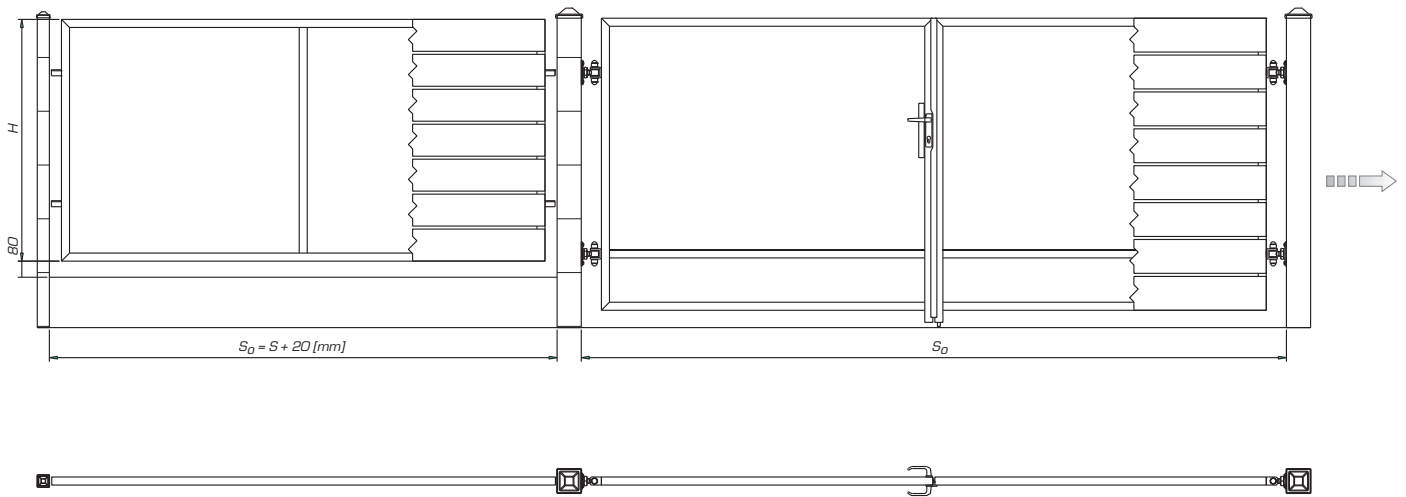
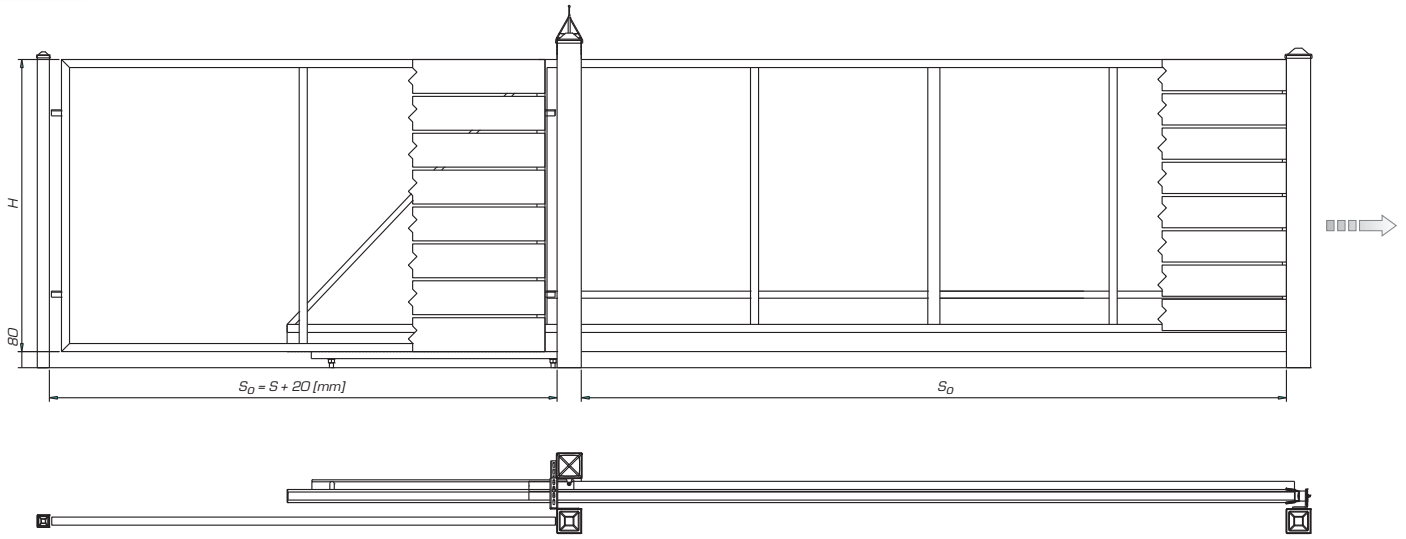

AW.10.PP/P

(S) 2500 [mm] x (H) 900 [mm]

(S) 2500 [mm] x (H) 1450 [mm]

(S) 2500 [mm] x (H) 1200 [mm]

max: (S) 3000 [mm] x (H) 1950 [mm]

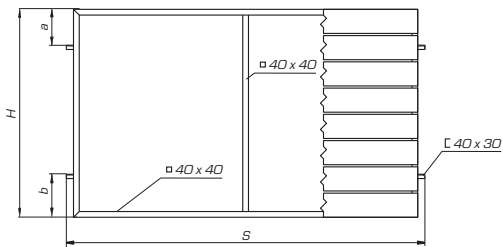

H = 1450, a = 250, b = 300

H = 1200, a = 250, b = 300

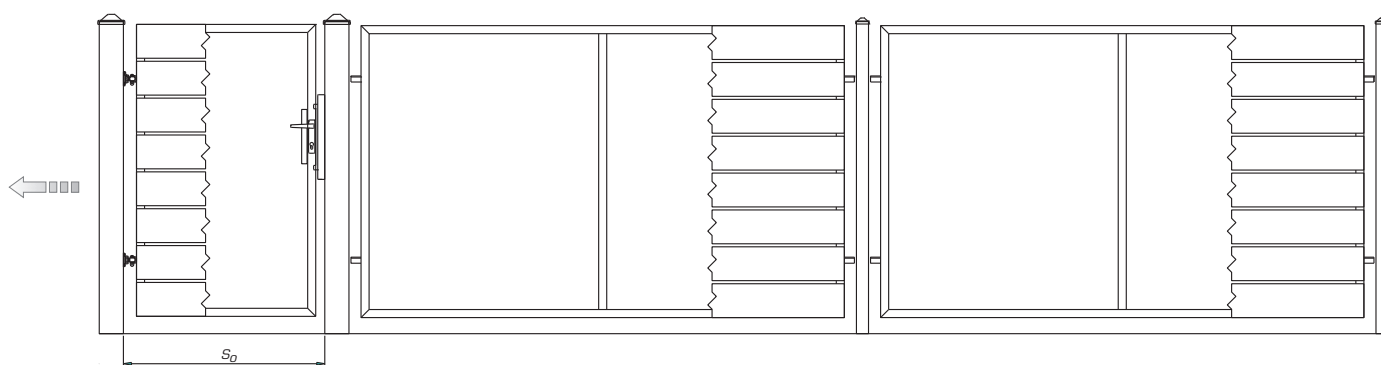
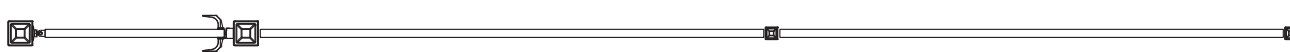
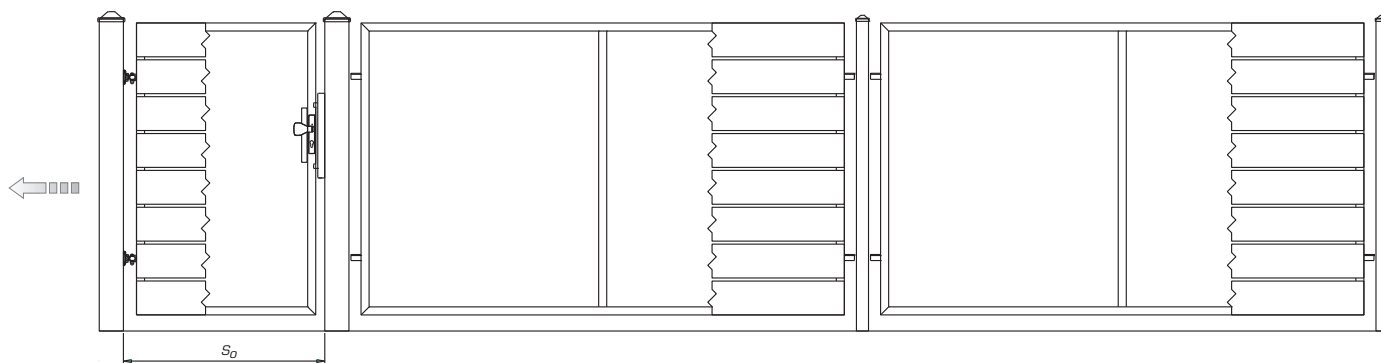

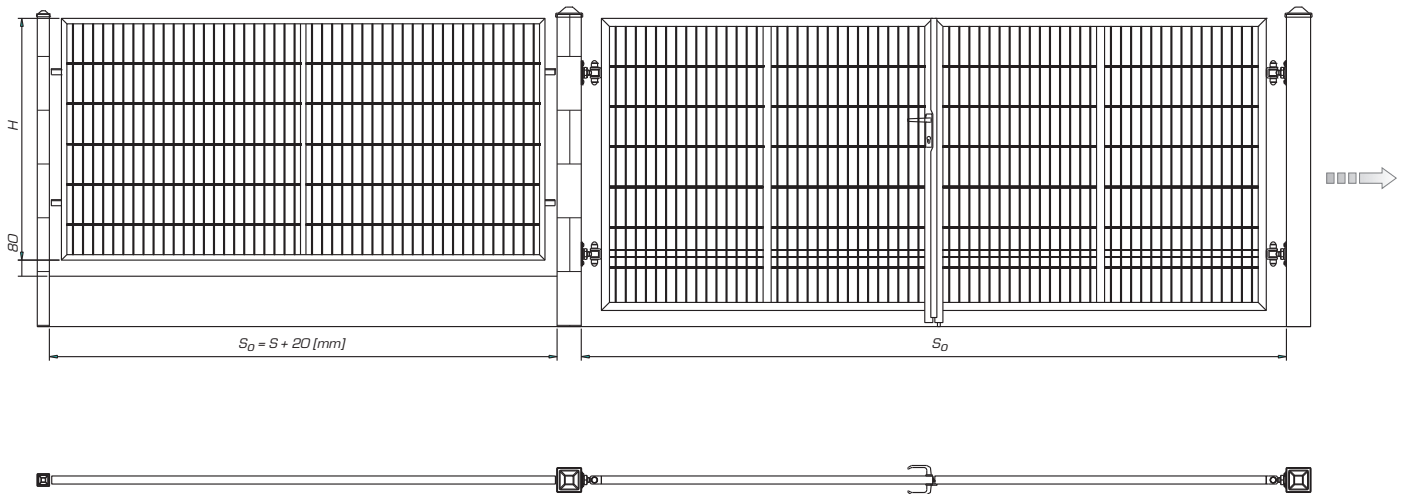
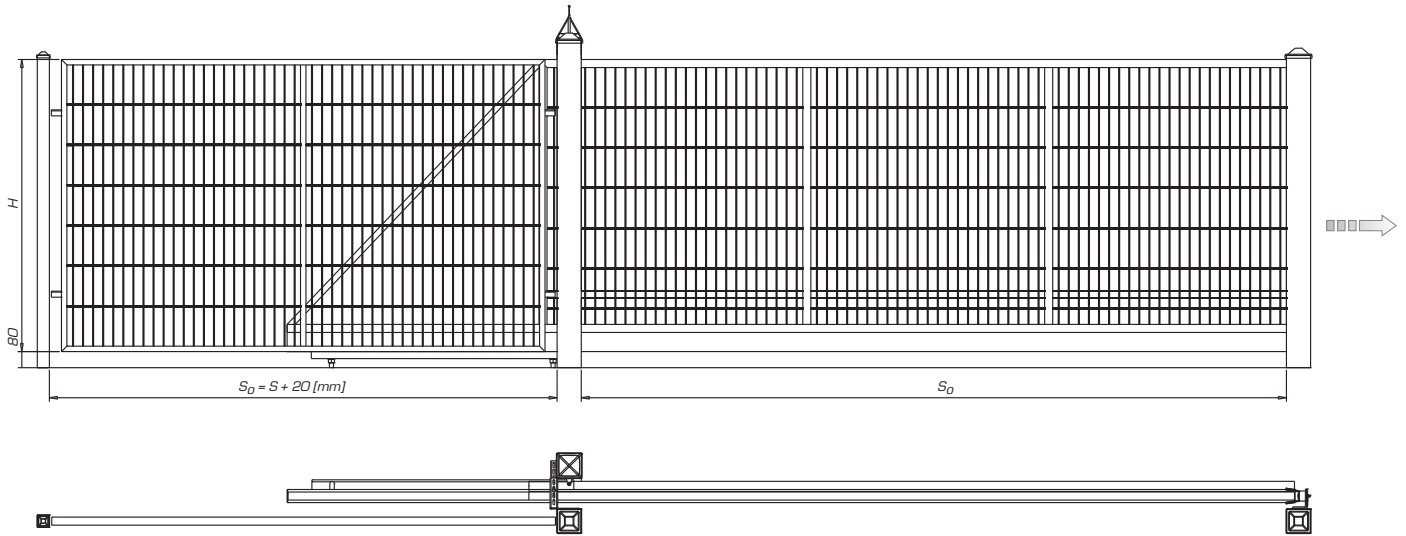

AW.VA.55/P

(S) 2500 [mm] x (H) 900 [mm]

(S) 2500 [mm] x (H) 1450 [mm]

(S) 2500 [mm] x (H) 1200 [mm]

max: (S) 3000 [mm] x (H) 1950 [mm]

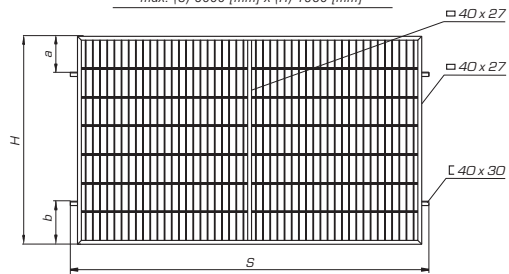

H=1450, a=250, b=300

H=1200, a=250, b=300

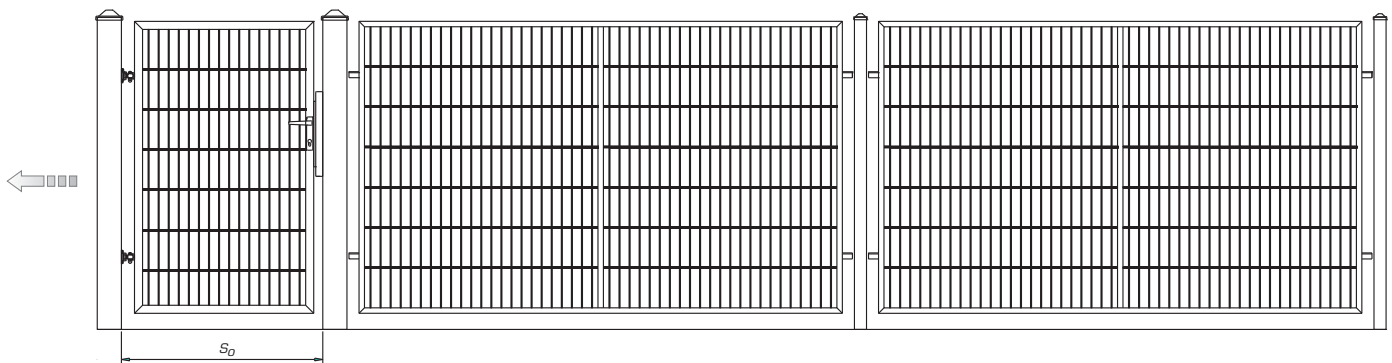
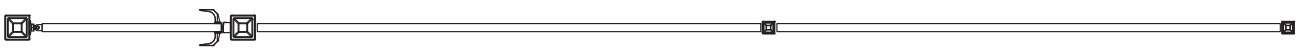
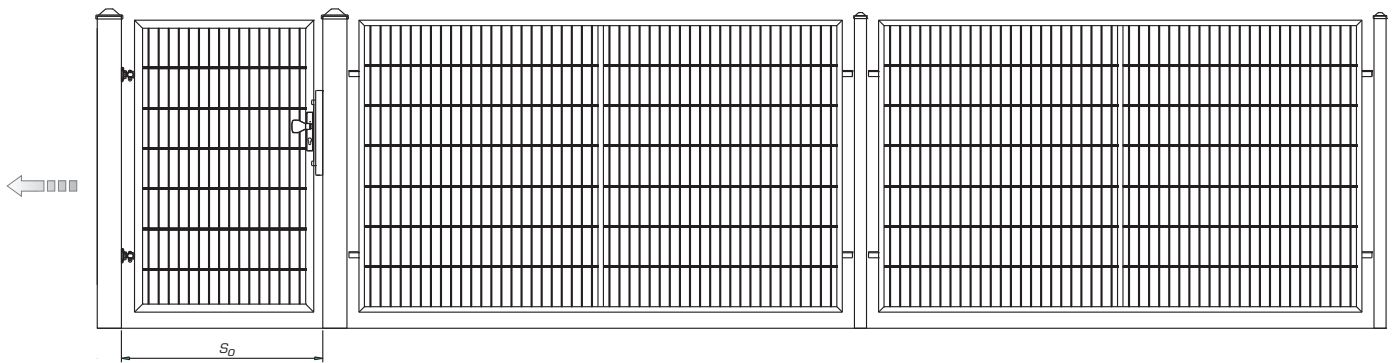

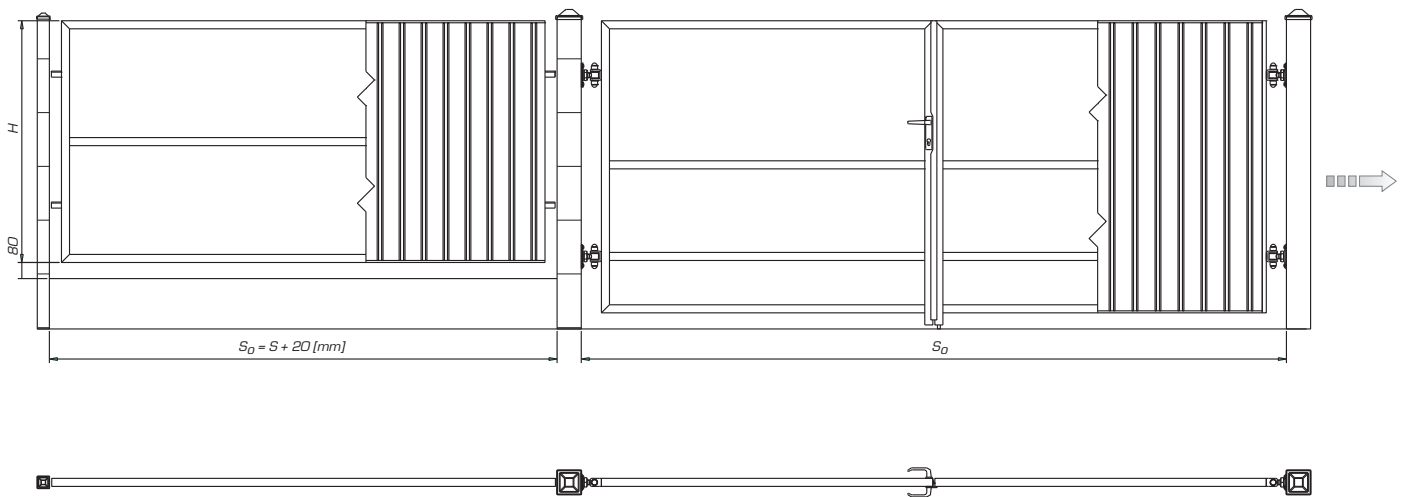
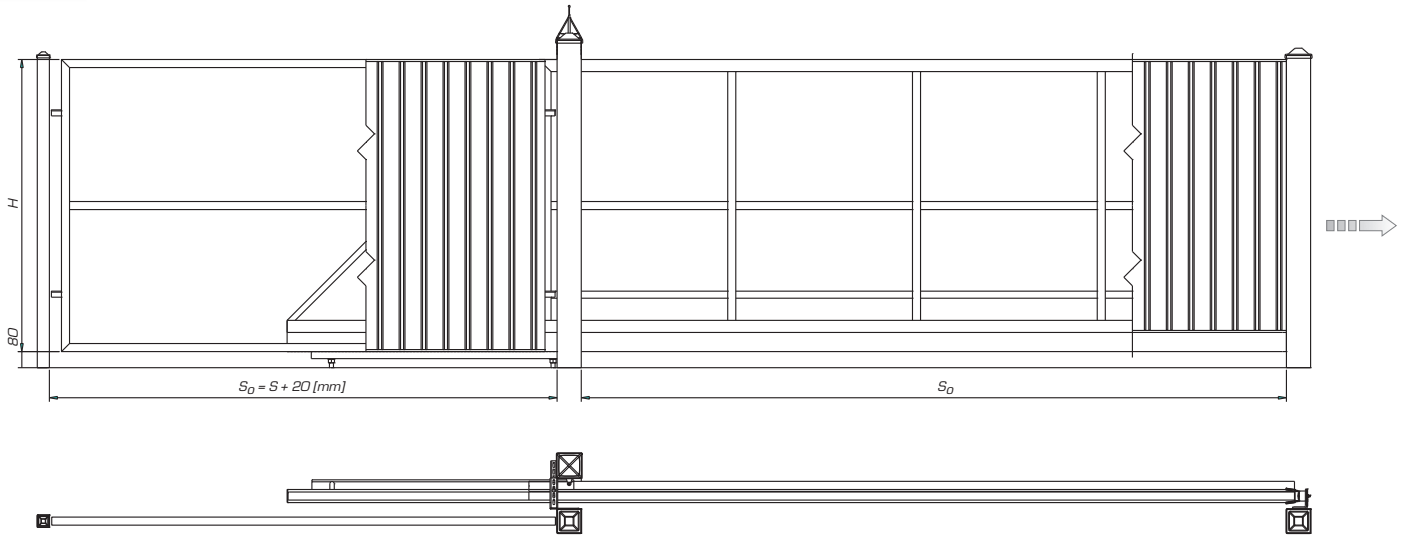

AW.10.TT/P

(S) 2500 [mm] x (H) 900 [mm]

(S) 2500 [mm] x (H) 1450 [mm]

(S) 2500 [mm] x (H) 1200 [mm]

max: (S) 3000 [mm] x (H) 1950 [mm]

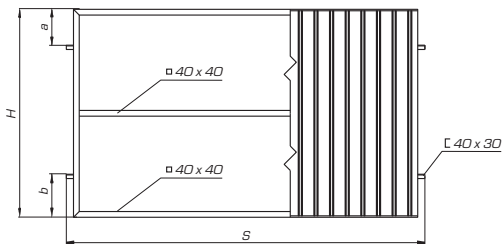

H=1450, a=250, b=300

H=1200, a=250, b=300

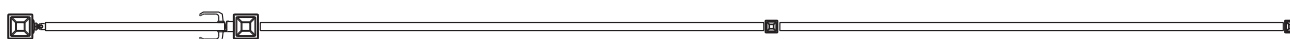
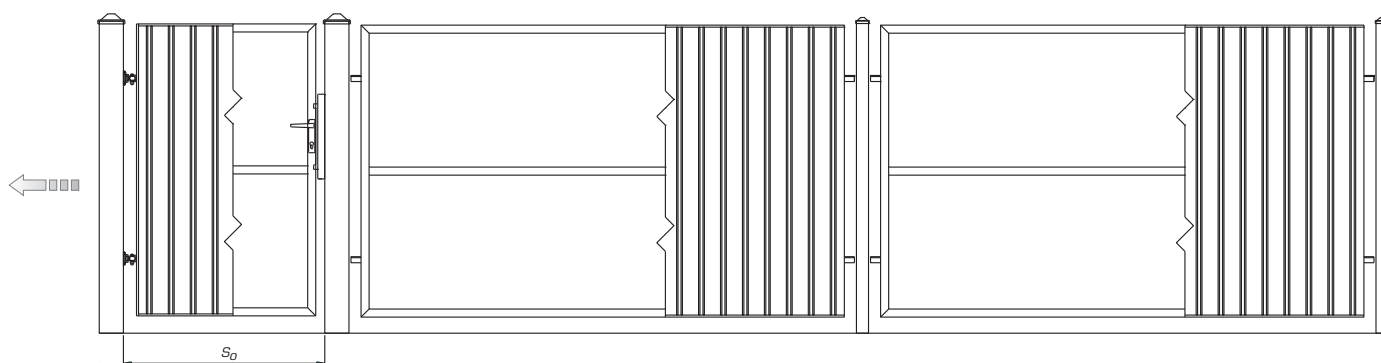
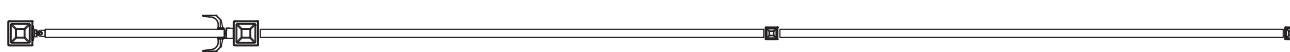
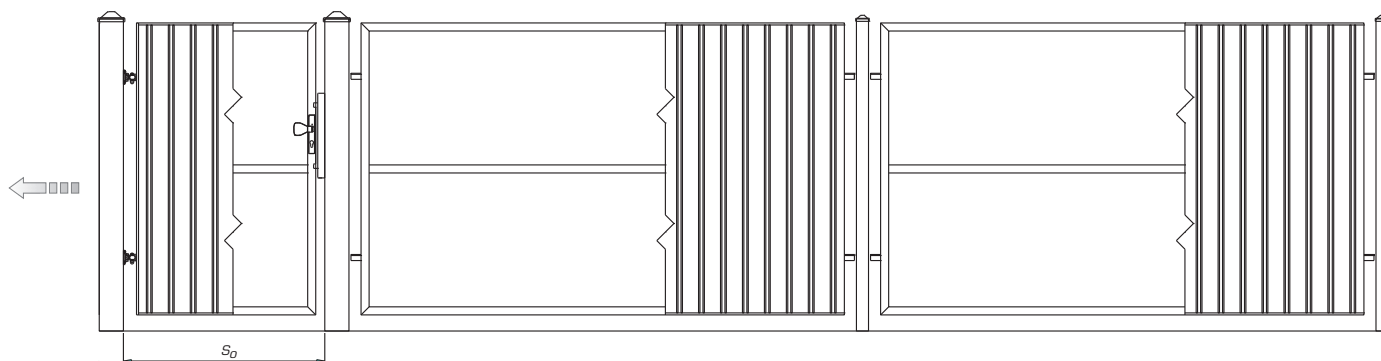



**Firma WIŚNIEWSKI**

PL / 33-311 Wielogłowy 153

Tel. +48 18 44 77 111

Fax +48 18 44 77 110

[www.wisniowski.pl](http://www.wisniowski.pl)

N = 49° 40' 10"

E = 20° 41' 12"